

Surge protection reinvented

Safe Energy Control Technology



RSPSupply - 1-888-532-2706 - <https://www.RSPSupply.com>
See the product details here

In dialog with customers and partners worldwide

Phoenix Contact is a globally present market leader with its corporate headquarters in Germany. Our group of companies is synonymous with future-oriented components, systems, and solutions in the fields of electrical engineering, electronics and automation. A global network across more than 100 countries with 14,500 employees ensures close proximity to our customers, which we believe is particularly important.

The wide variety of our innovative products makes it easy for our customers to find future-oriented solutions for different applications and industries. This is especially true for the fields of energy, infrastructure, process and factory automation.





Safe Energy Control Technology [®]

Designed by PHOENIX CONTACT

Safe lighting current and surge protection for the power supply

Lightning currents and surge voltages cause damage to devices and components. In the worst case scenario, the system could even fail. Downtime and repairs then lead to high costs. The solution: surge protection from Phoenix Contact.

Find out more with the web code

You can find web codes in this brochure: a pound sign followed by a four-digit number combination.



Web code: #1234 (example)

This allows you to access information on our website quickly.

It could not be easier:

1. Go to the Phoenix Contact website
2. Enter # and the number combination in the search field
3. Get more information and product versions

Or use the direct link:

[phoenixcontact.net/webcode/#1234](https://www.phoenixcontact.net/webcode/#1234)

Contents

Surge protection from PHOENIX CONTACT	4
Safe Energy Control Technology	6
The SEC range	8
FLASHTRAB-SEC-HYBRID	10
FLASHTRAB-SEC-PLUS-440	12
FLASHTRAB-SEC-PLUS-350 and ...-264	14
FLASHTRAB-SEC-T1+T2	16
VALVETRAB-SEC	18
VALVETRAB-SEC DC	20
PLUGTRAB-SEC	22
The all-around complete package	24
The SEC range in use	26
Selection guide	28

Surge protection from Phoenix Contact: Leading in technology

To meet the demands of the market, Phoenix Contact places the highest value on new and ongoing development of technologies. This happens in close coordination with technical universities and colleges.

One excellent example of this is the new spark gap with Safe Energy Control technology. Professionally developed, designed and tested in our pulse and high-current laboratory, lightning current protective devices and surge protective devices from Phoenix Contact provide the perfect protection for any power supply.

Tested down to the smallest detail

All products are tested in the Phoenix Contact test lab from their earliest stages.

The lab is accredited based on DIN EN ISO/IEC 17025. Operation of the lab demonstrates its expertise in specialized and technical fields as well as its independence and nonpartisan approach toward third parties.



Developing with innovation

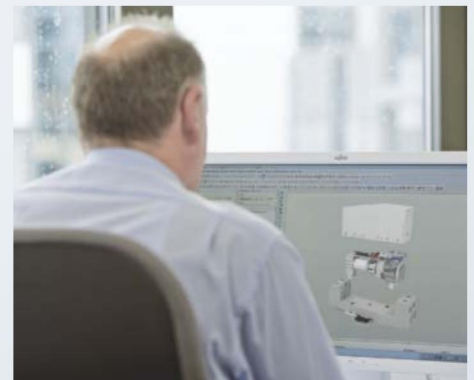

CAD-supported design

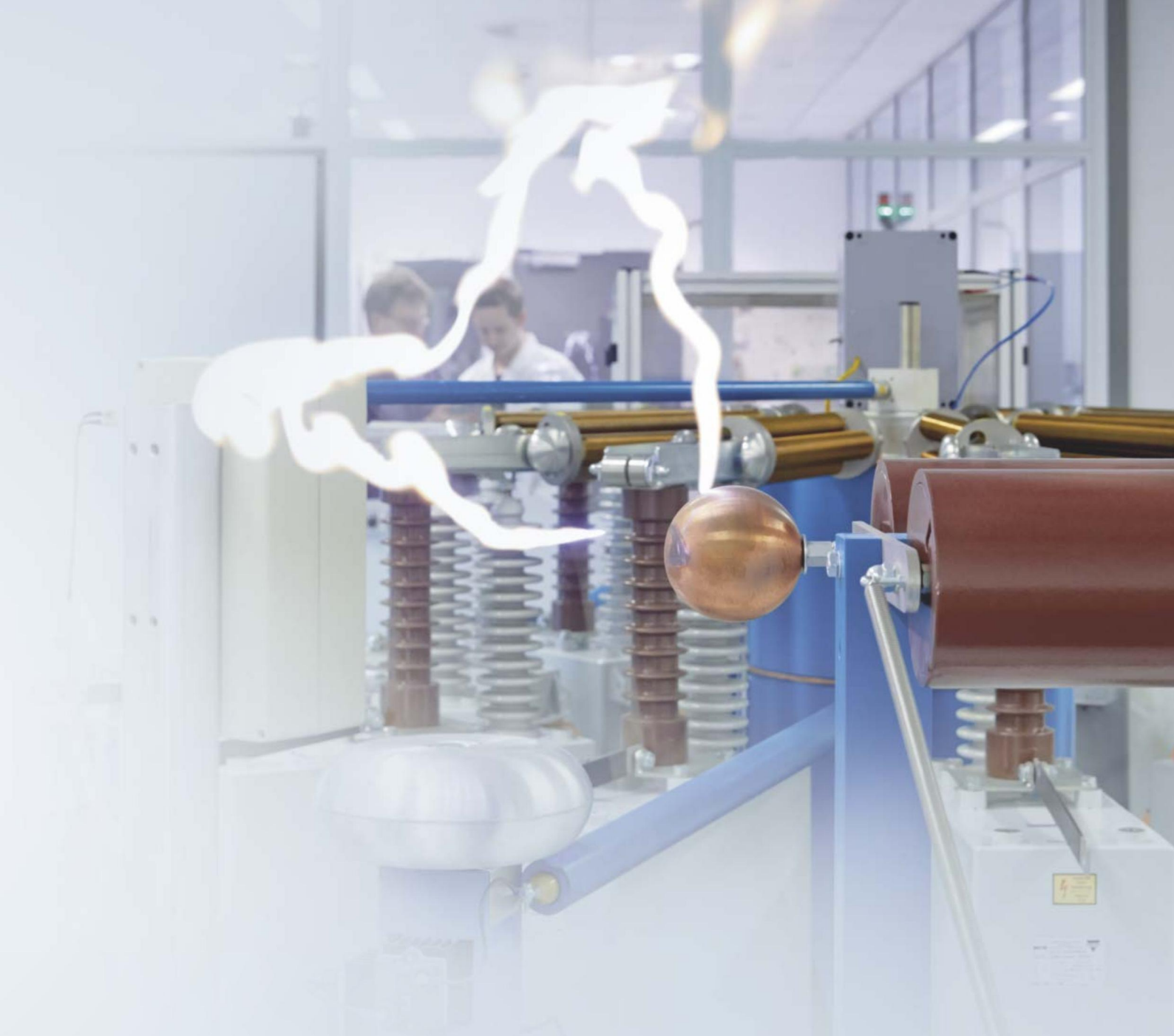

High-performance testing



Normative testing



Accredited testing

Safe Energy Control Technology: Surge protection without line follow current or backup fuses

Safe Energy Control, abbreviated SEC, is synonymous with outstanding durability and maximum performance in the area of lightning current and surge protection.

The revolutionary spark gap technology safely prevents any line follow current. This reduces the load on the entire installation to a minimum. This means outstanding durability for the surge protective devices at the same time.

The protective devices work quietly in the background and help protect the entire system. Backup-fuse-free solutions are available for all applications.

 Web code: #1133

Use without backup fuses

The SEC range lightning current protective devices and surge protective devices can be used without a separate arrester backup fuse up to a main fuse nominal current of 315 A. If the main fuse has a higher nominal current, the SEC product range provides a combination of an encapsulated spark gap with an integrated surge-current-proof backup fuse, the FLT-SEC-HYBRID.



Line follow current definition

The line follow current is the part of the current that flows through a spark gap from the power supply network after a surge voltage event is stopped. This type of line follow current can last up to a few milliseconds and have the intensity of a short-circuit current.

This means line follow currents put a strain on the entire installation. This can cause voltage dips and subsequent malfunctions as a result. Additionally, an upstream overcurrent protective device can be triggered in some circumstances.

The type 1 protective devices of the SEC range are the first of their kind to feature spark gaps without line follow current. They embody the ideas of high system availability, protected equipment and a secured installation.

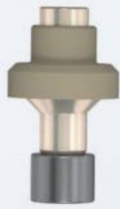

Spark gap without line follow current

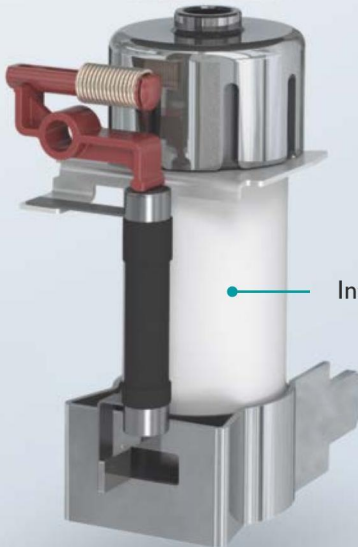

Integrated backup fuse



Safe Energy Control Technology 

Designed by PHOENIX CONTACT

The SEC range: A feeling of security

The SEC range of protective devices forms the perfect protection against lightning currents and surge voltages.

The newly developed spark gaps in combination with the type 2 and type 3 protective devices provide an absolutely indispensable protection concept for the power supply. The uniform, compact design and universal plug-in feature make the SEC range an installation-friendly overall package.

 Web code: #0291

Global approvals

The lightning current and surge protective devices with Safe Energy Control technology are tested by various institutions, such as KEMA, UL and GL.



Large-surface marking areas



Easy handling



Shared floating remote indication contact

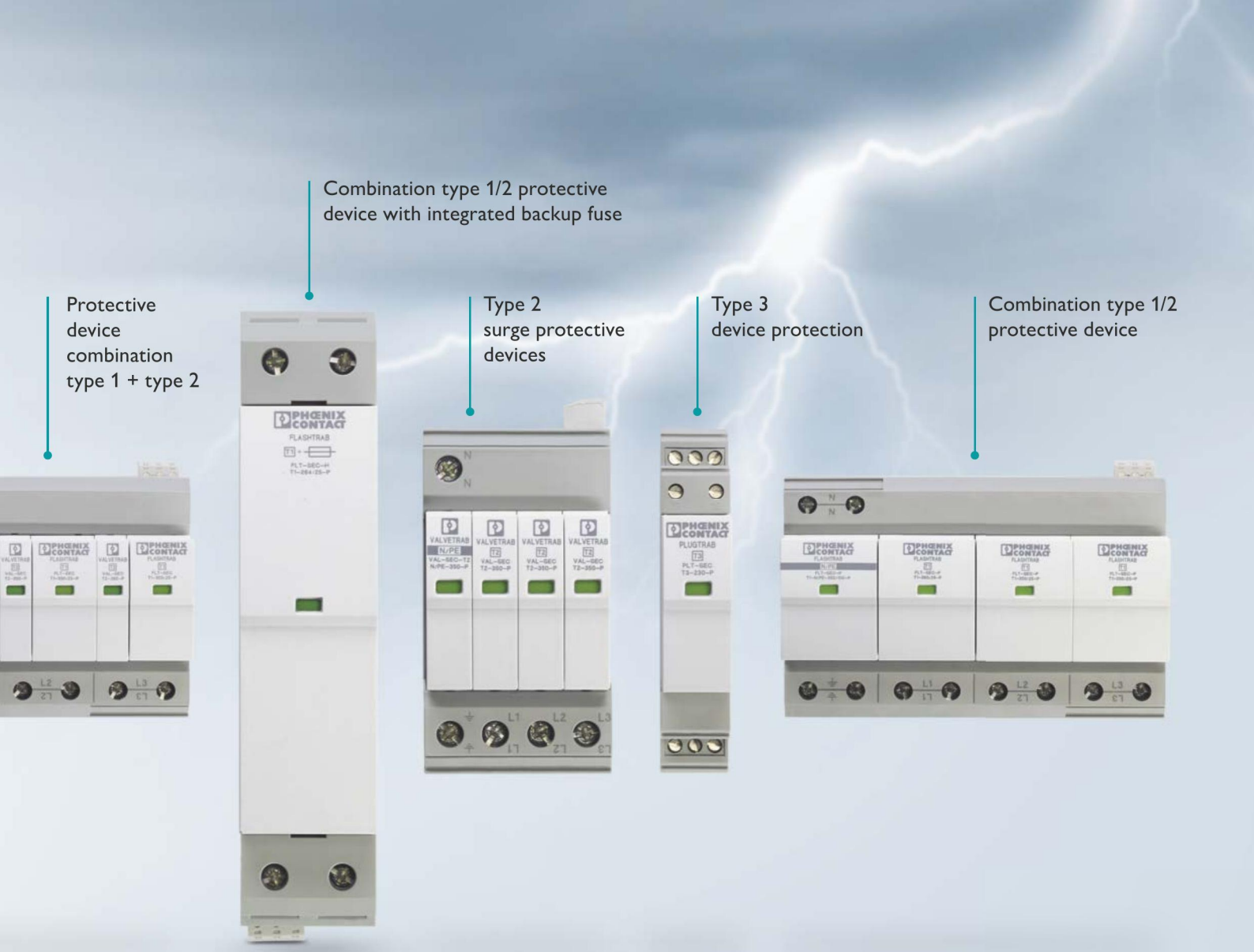

Combination type 1/2 protective device with integrated backup fuse

Protective device combination type 1 + type 2

Type 2 surge protective devices

Type 3 device protection

Combination type 1/2 protective device



Can be rotated by 180° in the application



Easily visible mechanical status indicators in signal colors



Unmistakable coding of all protective plugs

FLASHTRAB-SEC-HYBRID: The only pluggable combination of its kind in the world

FLASHTRAB-SEC-HYBRID is the first pluggable type 1 protective device with an integrated backup fuse combined with a high-performance spark gap without line follow current. Thanks to the integrated backup fuse, installation is easy and flexible, and you save space while reducing wiring effort.

The FLASHTRAB-SEC-HYBRID is available for 230/400 V and 400/690 V power supply systems. The high short-circuit withstand capability provides optimum conditions for protecting the power supply of industrial plants and wind turbine generators. Thanks to the pluggable feature of the protective device, it is not necessary to intervene in the installation when servicing it.

Your advantages:

- Low voltage protection level
- No external arrester backup fuse required
- Saves space in the control cabinet
- Long service life of the electrical installation
- Maximum system availability
- Easy replacement during servicing
- Can be tested with CHECKMASTER 2
- Satisfies TOV requirements for use in IT systems

Easily visible mechanical **status indicator** for backup fuse and spark gaps



FLASHTRAB-SEC-HYBRID in use



Wind turbine generator

Spark gap without line follow current

i Web code: #0644

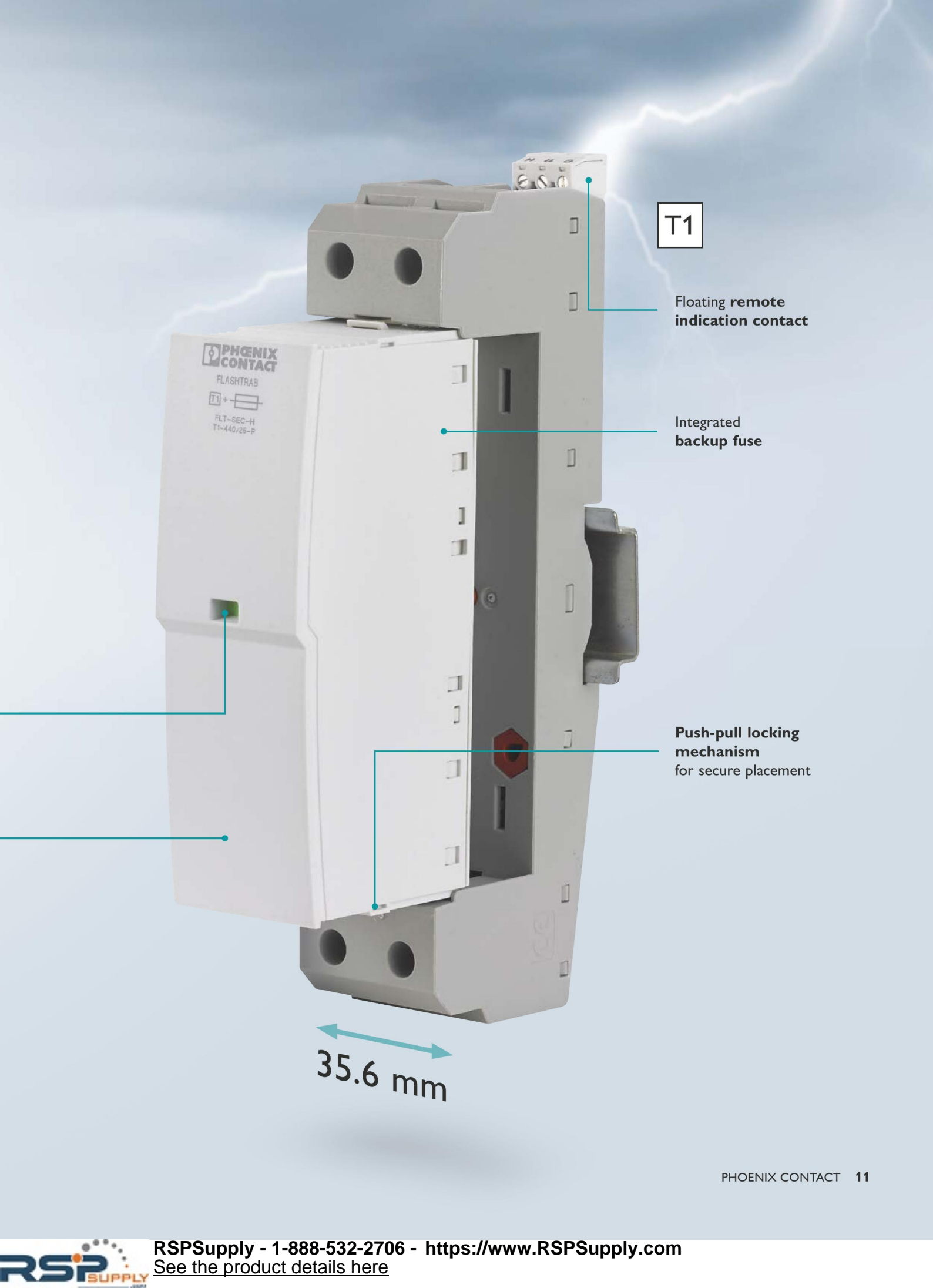

T1

Floating remote indication contact

Integrated backup fuse

Push-pull locking mechanism for secure placement

35.6 mm

FLASHTRAB-SEC-PLUS-440: The compact power package for 400/690 V

The technical performance of the FLASHTRAB-SEC-PLUS-440, especially the high discharge capacity of 35 kA, is one-of-a-kind feature for its format. The compact type 1 protective device is used in 400 V IT and 400/690 V TN-C power supply systems. The new N/PE spark gap for higher nominal voltages also enables a 3+1 circuit especially for TN-S and TT systems.

Thanks to the high continuous voltage of 440 V and the strong shock and vibration resistance, it is perfectly suited for use in industrial plants and wind turbine generators.

Its compact design and the comprehensive pluggable feature of the protective devices make installation space-saving and flexible.

Your advantages:

- Low voltage protection level
- No external arrester backup fuse required up to 400 A gG
- Long service life of the electrical installation
- Satisfies TOV requirements for use in IT systems
- Shock and vibration tested
- Maximum availability of the system
- Saves space in the control cabinet
- Easy replacement during servicing
- Can be tested with CHECKMASTER 2

Spark gap without line
follow current



FLASHTRAB-SEC-PLUS-440
in use

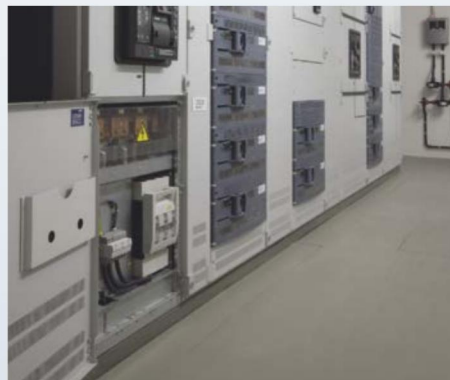

Low voltage supply

i Web code: #0646

Consistent **status indicator** for all protective plugs

Simple installation block, **no additional bridging** required

Floating remote **indication contact**

T1

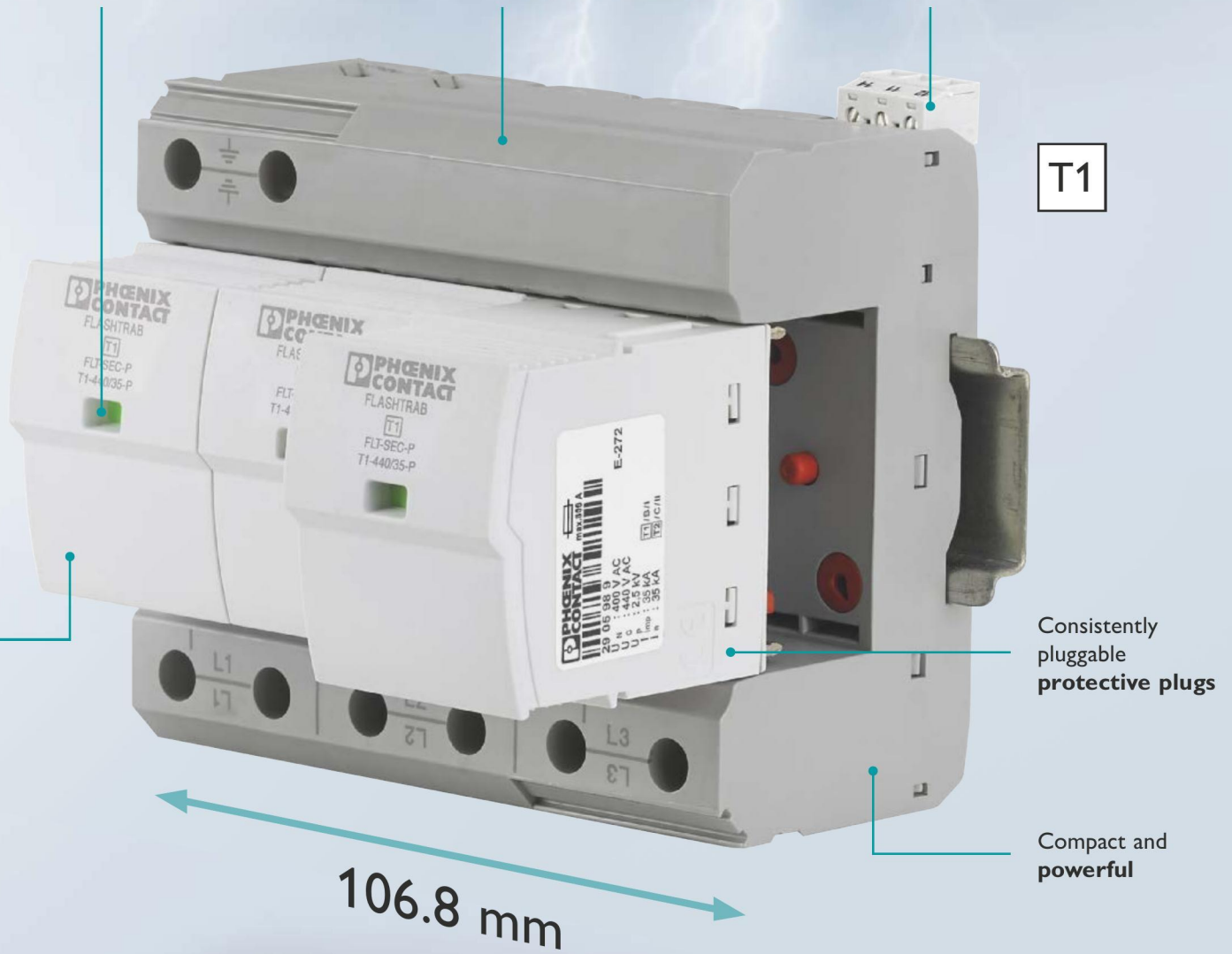

Consistently pluggable **protective plugs**

Compact and **powerful**

FLASHTRAB-SEC-PLUS-350 and ...-264: Powerful and compact for 230/400 V

FLASHTRAB-SEC-PLUS-350 and ...-264 are ideal for use in the unmetered area of the main supply and for industrial applications.

The powerful spark gaps without line follow current protect your systems every step of the way and significantly increase the service life of the electrical installation. High voltage fluctuations are no problem for the FLASHTRAB-SEC-PLUS-350, which features a top continuous voltage of 350 V AC. Extreme lightning current loads of 50 kA per position highlight the performance of the FLASHTRAB-SEC-PLUS-264.

Similarly to all other SEC range type 1 protective devices, the FLASHTRAB-SEC-PLUS-350 and ...-264 are also tested and certified as type 2 protective devices.

Your advantages:

- Suitable for almost all network configurations
- Low voltage protection level
- No external arrester backup fuse required up to 315 A gG or 500 A gG
- Spark gap without line follow current
- Long service life of the electric installation
- Maximum availability of the system
- Easy replacement during servicing
- Can be tested with CHECKMASTER 2

Spark gap without line follow current



FLASHTRAB-SEC-PLUS in use



Low voltage supply

i Web code: #0113

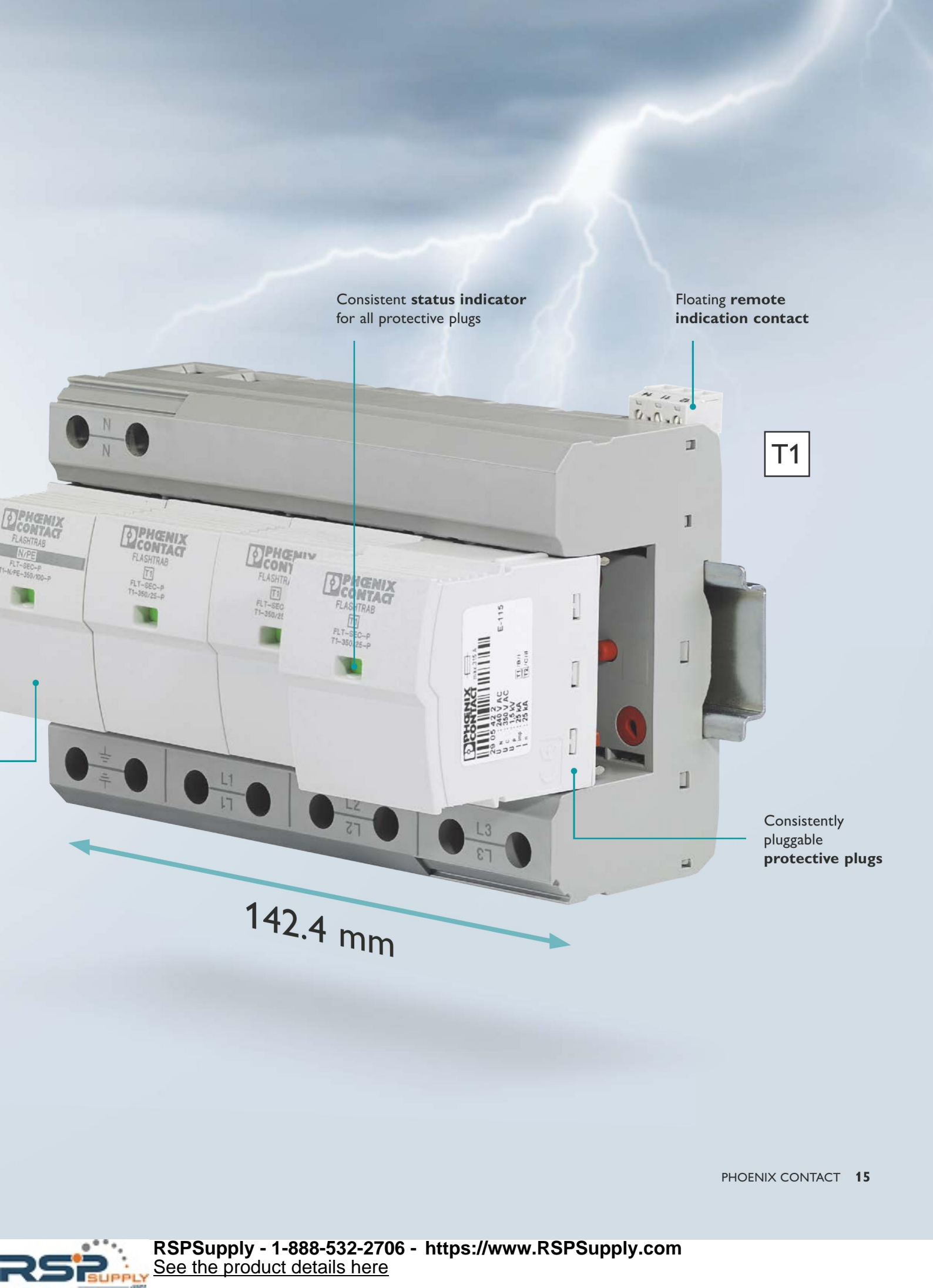

Consistent **status indicator** for all protective plugs

Floating **remote indication contact**

T1

Consistently **pluggable protective plugs**

142.4 mm

FLASHTRAB-SEC-T1+T2: One-of-a-kind, real combination of type 1 and type 2 protective devices

The FLASHTRAB-SEC-T1+T2 is the combination of a lightning current arrester and surge protective device. This type of arrester is the ideal protection for environments with frequent switching operations. Lightning currents are safely controlled by the powerful spark gap. This guarantees a low residual voltage, while dynamic surge voltages are reliably limited by the varistor-based type 2 protective devices. The setup provides optimal coordination between a spark gap and the varistor.

The combined protective device, which has been the only one of its kind for twelve years, provides considerable reduction in installation and maintenance expenses. It is now also available with a spark gap without line follow current and with a newly developed type 2 protective device.

Your advantages:

- Installation effort reduced to a minimum
- Low voltage protection level
- No external arrester backup fuse required up to 315 A gG
- Optimum protection even at the lowest surge voltages
- Long service life of the electrical installation
- Maximum availability of the system
- Saves space in the control cabinet
- Easy replacement during servicing
- Can be tested with CHECKMASTER 2

Spark gap without line
follow current

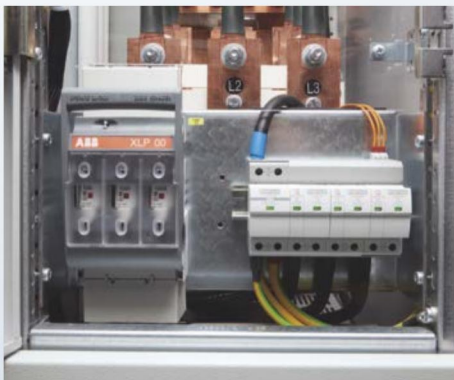

FLASHTRAB-SEC-T1+T2 in use



Low voltage supply

i Web code: #0116

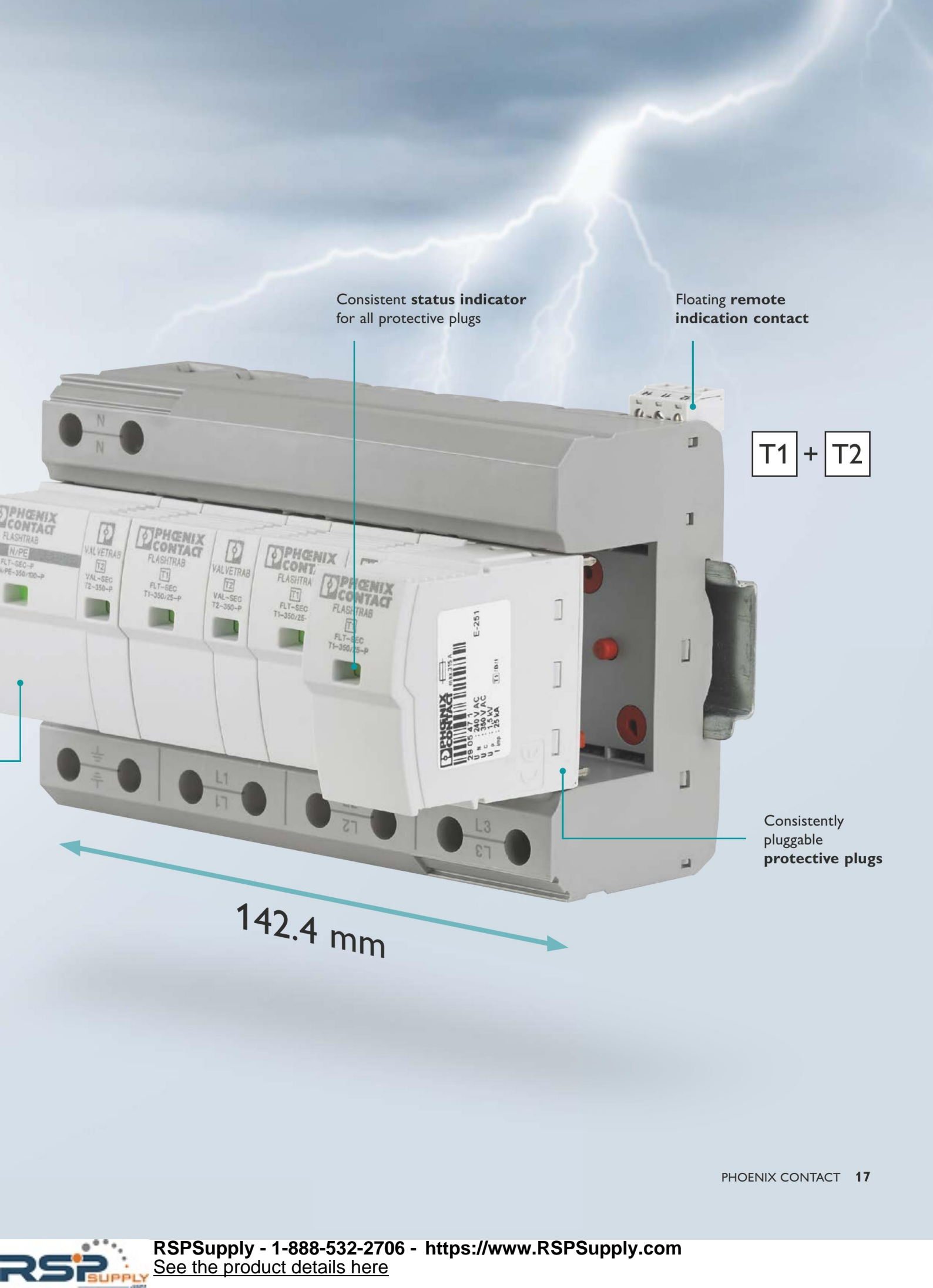

Consistent **status indicator** for all protective plugs

Floating **remote indication contact**

T1 + **T2**

Consistently pluggable **protective plugs**

142.4 mm

VALVETRAB-SEC: Narrowest plug-in surge protective device in the world

The type 2 compact surge protective device provides maximum performance and high short-circuit withstand capability with a 12 mm overall width for each channel. This allows the VALVETRAB-SEC to be accommodated in every small distribution panel without problems and without using a separate arrester backup fuse up to a nominal current of the main fuse of 315 A. The high discharge capacity and the low overall width mean that the VALVETRAB-SEC provides reliable surge protection for every power supply.

Within the VALVETRAB-SEC product range, various versions are available, including those for different voltage levels, a version without leakage current or a version with increased discharge capacity in the N/PE path.

Your advantages:

- Low voltage protection level
- Powerful disconnect device
- No external arrester backup fuse required up to 315 A gG
- High short-circuit withstand capability: up to 50 kA
- Saves space in the control cabinet
- Easy replacement during servicing
- Can be tested with CHECKMASTER 2
- Various versions are available, depending on the application environment

Consistent **status indicator**
for all protective plugs

Consistently **pluggable**
protective plugs

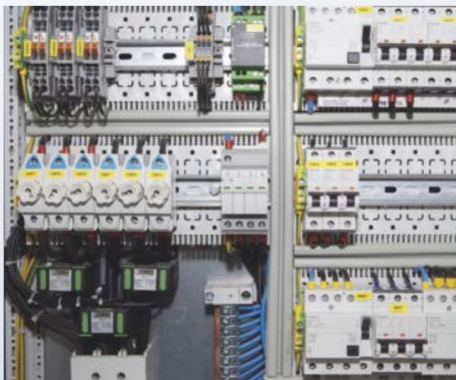

VALVETRAB-SEC in use

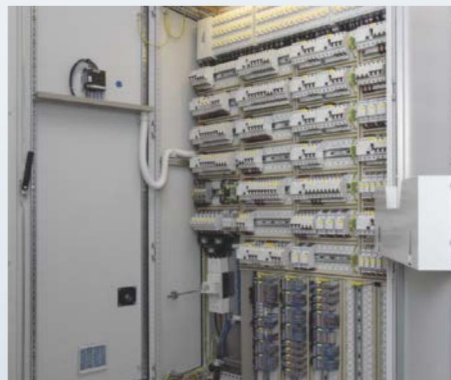

Sub-distributor

 Web code: #0117

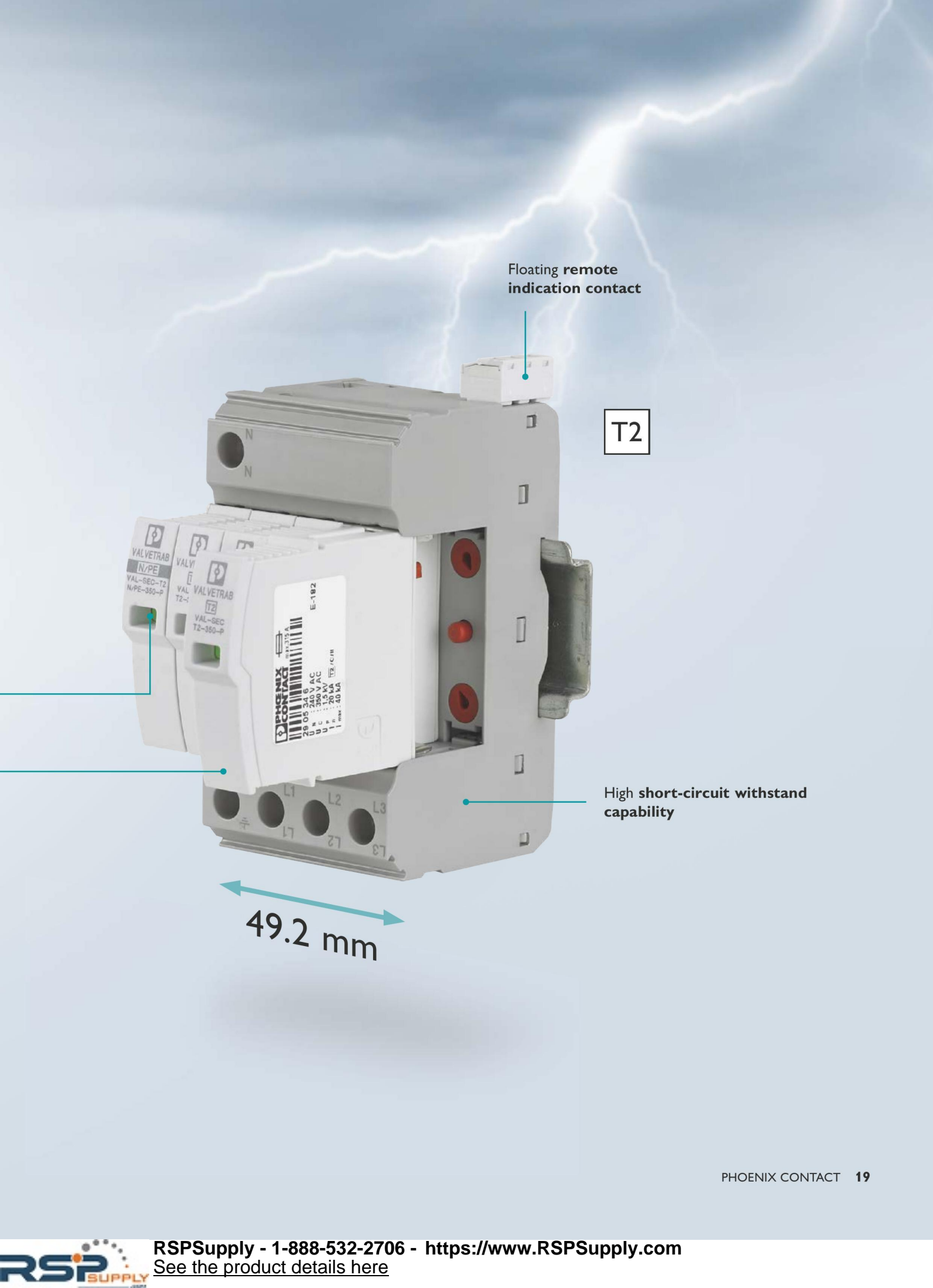

Floating remote indication contact

T2

High short-circuit withstand capability

49.2 mm

VALVETRAB-SEC DC: Surge protective device for linear direct-current applications

The VALVETRAB-SEC DC is ideally suited for protecting linear DC power sources. With an overall width of only 12 mm per channel, the type 2 surge protective device is very compact and versatile in use. The powerful disconnect device provides maximum protection for all standard 48/120/220/380 V DC applications. The high extinguishing capability of the protective device eliminates the need for a backup fuse. Sensitive downstream components are optimally protected, thanks to the low voltage protection level.

Your advantages:

- Low voltage protection level
- Powerful disconnect device
- No external arrester backup fuse required up to 200 A
- Saves space in the control cabinet
- Easy replacement during servicing
- Can be tested with CHECKMASTER 2



VALVETRAB-SEC DC in use



Data centers

 Web code: #1125



Floating remote indication contact

T2

Consistent **status indicator** for all protective plugs

High **extinguishing capability**

Consistently **pluggable** protective plugs

25.4 mm

PLUGTRAB-SEC: High-performance device protection for AC and DC

The PLUGTRAB-SEC is the powerful type 3 surge protection solution for end devices up to a nominal voltage of 230 V.

The newly developed internal disconnect device provides increased safety in the case of electric and thermal overloads, regardless of the installed backup fuse.

For this reason, the PLUGTRAB-SEC is the reliable surge protection solution for AC and DC end devices.

Your advantages:

- Safe behavior in case of overload, thanks to powerful internal separation
- Easy replacement during servicing
- Can be used in AC and DC applications from 24 V to 230 V
- Easy through wiring up to a load current of 26 A
- No external arrester backup fuse required in the branch, e.g. behind 40 A power supply units
- Reliable remote status signalling
- Can be tested with CHECKMASTER 2



Power supply protection

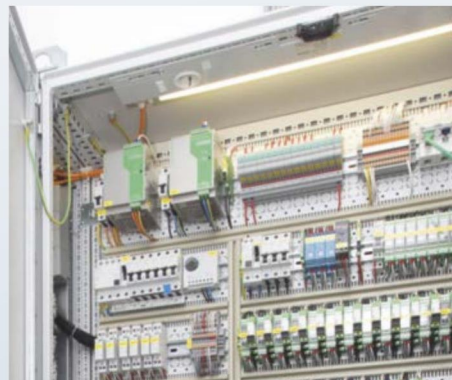

Sub-distributor

 Web code: #0118

Floating remote indication contact

T3

Powerful, internal disconnecting technology

Base element with through wiring

Pluggable and coded device protection

LED status indicator

- Protective device O.K.
- Overloaded, replacement required

17.7 mm



PLUGTRAB SEC-3S

Device protection for three-phase 230/400 V systems

The all-around complete package: Surge protection from PHOENIX CONTACT

The all-around complete package in terms of surge protection for the power supply: The protective devices with Safe Energy Control technology are extremely powerful and durable – for greater availability and a lower total load on the system. Because of our confidence in their capabilities, we offer replacement plugs free of charge for the first five years after purchase when you return a plug with a red status indicator.



The CHECKMASTER 2 provides a convenient and to check all SEC range protective plugs on-site to ensure compliance with standards.

Everything in the green – we're betting that you won't see red for five years

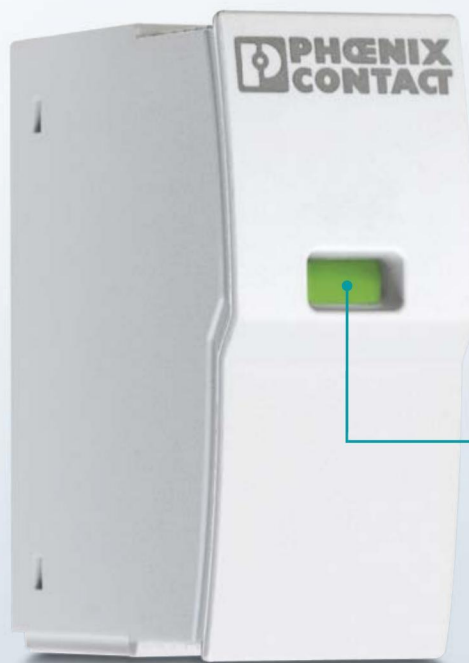
With our low-wear protective devices, you won't have to worry about replacing wear parts for at least five years. Thanks to the SEC technology, the high-quality components are particularly durable. However, if the status indicator signals the need for replacement within this period, you will receive a free replacement within the first five years following your purchase. Simply send the affected plug back to us.*



Status indicator on each module

-  Protective device O.K.
-  Overloaded, replacement required

The CHECKMASTER 2 – everything you need for testing

The second generation CHECKMASTER can be used to test all SEC range surge protective devices conveniently, safely and quickly according to requirements in accordance with IEC 62305-3 and all government agency guidelines. Recurring tests are documented and saved reliably using the CHECKMASTER 2.

Of course, the CHECKMASTER 2 is also backward compatible. As a result, almost all existing surge protection products from the Phoenix Contact portfolio can be tested.

Step 1

Scan a test object



Step 2

Insert the test object



Step 3

Carry out reliable testing



Step 4

Save results easily so they can be tracked

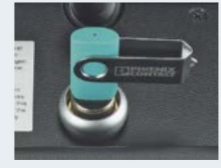

Display of test results in the LC color display

- Protective plug functional
- Protective plug damaged – replacement recommended
- Protective plug defective – must be replaced

The **CHECKMASTER 2** tests and documents devices in accordance with IEC 62305.

The **sturdy case** ensures safe transport and provides space for your documents and other items.

It couldn't be any easier – the integrated **hand-held scanner** detects the test object via the barcode without error.

The **storage area below the scanner** provides space for another test adapter.

The **USB port** allows you to save data to a USB stick. Software updates can be carried out in the same manner.

The intuitive, menu-driven user interface of the **touch panel** enables easy and convenient handling during testing.

For the CHECKMASTER 2, **test adapters for the various protective plugs** are available.

 Web code: #0108



The SEC range in use: Protection for any power supply

Businesses in every industry expect a high degree of availability.

With individualized solutions for requirements in a wide variety of applications, state-of-the-art surge protection makes a significant contribution to meeting this demand.

Building installation

Universal solutions for surge-voltage-resistant building services and convenient installation in commercial and residential buildings.

Energy supply

Durable and reliable surge protection for uninterrupted supply in industry, businesses and private households.

Telecommunications

Impact-free and approved protective devices for high availability of all communication networks.



Infrastructure

High-performance surge protection for interruption-free supply, transportation and traffic.



Wind power

Robust protective devices for the harsh ambient conditions in wind turbine generators.



Machine building

Space-saving protective devices in compact control cabinets for uninterrupted system operation.

Data centers

Effective surge protection for linear DC voltage applications in data centers and for emergency lighting.

Selection guide

In the accompanying selection guide you will find the products of the SEC range in their corresponding application areas. This makes searching for the correct surge protective device for your application easier.

Energy supply

Protection of the energy supply from failure due to surge voltage damage must be reliably ensured at all times. To this end, it is particularly important that the installation not be tampered with during maintenance and replacement. The SPDs of the Safe Energy Control portfolio fulfill this requirement with consistently pluggable protection modules. Type 1 SPDs of the FLASHTRAB-SEC-HYBRID product range are designed to be pluggable. Thus, in addition to the space and cost savings from the integrated backup fuse, it is also possible to perform maintenance easily and make a replacement without interrupting the power supply.



Infrastructure

The variety of areas within public infrastructure results in different requirements for the respective surge protection, which have to be addressed through special properties of the SPDs. SPDs without leakage current, for example, are frequently required in rail transport to ensure that insulation monitoring systems in the installations are not

impaired. The type 2 SPDs of the VALVETRAB-SEC 350VF range offer this feature and have a particularly narrow overall width.



Wind power

It is of the utmost importance to have high-performance type 1 SPDs at the cable inlet and outlet that protects against the effects of direct lightning strikes in order to effectively protect wind turbine generators from surge voltage damage.

FLASHTRAB-SEC-PLUS 440 and FLASHTRAB-SEC-HYBRID 440 are specially designed for use in 400/690 V systems that are frequently used between a wind turbine generator and a feed-in transformer. The other control circuits of a wind turbine generator are optimally protected by type 2 SPDs from the VALVETRAB-SEC range and type 3 SPDs from the PLUGTRAB-SEC range.



Building installation

Protection of buildings with an external lightning protection system requires a type 1 SPD such as the FLASHTRAB-SEC-PLUS 350. To protect against the effects of direct lightning strikes, this is installed where the supply line enters the building in the unmetered area. If there is no external lightning protection system, a high-performance type 2 SPD such as the VALVETRAB-SEC 350/40 with increased discharge capacity in the N-PE path should be chosen for protection at the feed point of the installation.

Accordingly, type 2 SPDs from the VALVETRAB-SEC range are required in additional sub-distributors, and type 3 SPDs from the PLUGTRAB-SEC range should be used for device protection.



Telecommunications

Telecommunication systems are often greatly exposed to the elements and therefore at risk from the effects of direct lightning strikes. That is why most single-phase installations require a particularly high-performance type 1 SPD such as the FLASHTRAB-SEC-PLUS 264 with a high discharge capacity per position. Protection of sub-distributors and

sensitive devices is achieved through additional type 2 SPDs from the VALVETRAB-SEC range or type 3 SPDs from the PLUGTRAB-SEC range, even for devices supplied with DC voltage.



Machine building

Machines and associated electrical installations must be effectively protected against surge voltages, often without knowing the exact risk at the installation location.

The high-performance type 2 SPDs from the VALVETRAB-SEC range provide optimum protection in various designs with minimal installation space. Sensitive electronics are protected using the type 3 SPD from the PLUGTRAB-SEC range, even for devices supplied with DC voltage.



Data centers

To ensure the constant availability of data in today's information age, effective surge protection of data centers is indispensable. Most systems supplied with DC voltage are optimally protected by the type 2 SPDs of the VALVETRAB-SEC-DC range in the respective distributors. Protection of sensitive end devices is ensured by the type 3 SPDs from the PLUGTRAB-SEC range, which can also be used in DC voltage systems.





Always up-to-date, always available to you. Here you'll find everything on our products, solutions and service:

phoenixcontact.com

Product range

- Cables and wires
- Charging technology for E-Mobility
- Connectors
- Controllers
- Electronics housings
- Electronic switchgear and motor control
- Fieldbus components and systems
- Functional safety
- HMIs and industrial PCs
- I/O systems
- Industrial communication technology
- Installation and mounting material
- Lighting and signaling
- Marking and labeling
- Measurement and control technology
- Monitoring
- PCB terminal blocks and PCB connectors
- Power supply units and UPS
- Protective devices
- Relay modules
- Sensor/actuator cabling
- Software
- Surge protection and interference filters
- System cabling for controllers
- Terminal blocks
- Tools

PHOENIX CONTACT GmbH & Co. KG
Flachsmarktstraße 8
32825 Blomberg, Germany
Phone: +49 52 35 3-00
Fax: +49 52 35 3-4 12 00
E-mail: info@phoenixcontact.com
phoenixcontact.com

**PHOENIX
CONTACT**
INSPIRING INNOVATIONS



RSPSupply - 1-888-532-2706 - <https://www.RSPSupply.com>
See the product details here